

# Fire extinguisher assembly and service manual

## LES-RACK-M1



This manual gives the procedures for assembling, commissioning, operating and maintenance of the LES-RACK-M1 fire extinguisher. The equipment must only be used for the described applications with the approved extinguishing agent FK-5-1-12 and installed as described in this manual. Read carefully and keep the user manual

## Contents

Generally .....	3
Working conditions .....	3
<b>DESCRIPTION.....</b>	<b>4</b>
Technical parameters.....	4
Construction .....	4
Control – activation .....	7
Extinguishing .....	8
Inputs and Outputs .....	9
Signalling .....	11
General safety provisions .....	13
<b>HTML.....</b>	<b>14</b>
State.....	14
Network.....	16
Alarms .....	19
Temperatures.....	20
Mail .....	21
Outputs .....	21
Date and time .....	22
Logs.....	22
Download .....	22
<b>INSTALLATION .....</b>	<b>23</b>
General provisions.....	23
Safety provisions .....	23
Assembling the equipment .....	23
Filling, adding extinguishing liquid .....	23
<b>CHECKING AND COMMISSIONING.....</b>	<b>24</b>
Commissioning.....	24
Checking.....	24
Disconnecting equipment .....	24
<b>SERVICING.....</b>	<b>24</b>
General requirements .....	24
<b>MAINTENANCE .....</b>	<b>24</b>
General provisions.....	24
Inspections by the user .....	25
Inspections by the service organization.....	25

## GENERAL INFORMATION

### Generally

**LES-RACK-M1** is an independent, fully automatic, detection and fire extinguishing equipment. It is for fire fighting protection of telecommunication and control boxes, server boxes or other distribution boxes with a 19 "frame.

It consists of a fully equipped automated fire detection, control, evaluation, communication system and a fire fighting unit. The extinguishing agent is non-corrosive, does not damage data stored on record carriers. The extinguishing agent is non-conductive and can also be used to extinguish electric equipment with a nominal voltage up to 1,000 V.

The service life of the equipment, with the exception of the battery, is 10 years from the year of the production. The service life of the batteries depends on the working environment mainly at a working temperature of 25°C. Generally the higher the temperature the shorter the service life.

Because the principle of CONTEG, is to continuously improve its products, the company reserves the right to change this data without prior notification.

This device must only be used in accordance with the operating conditions in the accompanying documentation and the user manual.

If not used according to the designation the manufacturer is not liable for damages that may arise. In these cases the operator exclusively bears the risk.

The operator must carry out regular visual and functional inspections according to the operating conditions and the maintenance plan. In necessary, the maintenance and service must be documented.

Device operators must announce all changes and modifications of the monitored and protected device, any object that could influence the efficiency of the LES-RACK-M1 fire fighting system (e.g. shadowing of extinguishing nozzle when installing new equipment, adding or making new ventilation holes in the box. . etc.).

**NOTE: This "LES-RACK-M1 fire fighting device assembly and operation manual "is the working documentation for installing and commissioning the device. However, it cannot replace training.**

### Working conditions

The device must be installed in an environment protected against class 3K3 atmospheric influences according to EN 60721-3-3 with temperatures +5°C to 40°C. The device's working position and location in the protected space will affect its correct function. The working position must be always horizontal; the control panel of device must be easily accessible. The device must be in the highest possible place of the protected box. The device is guaranteed to work at temperatures from +5°C to 40°C with maximum 85% humidity and in an environment with no humidity condensation.

**NOTE: If the temperature of the device is above 45°C uncontrolled leaks of the extinguishing agent through the safety pressure valve may occur. This is because of the high temperature of the extinguishing agent in the tank at which it may be gradually turn to gas. Pressure increase in the tank. If the pressure reaches 3Bar the safety vale opens and the extinguishing agent may "flow-out "from the tank.**

# DESCRIPTION

## Technical parameters

Table No. 1 :

Basic LES-RACK-M1 parameters:	Value:
Output voltage the AC network	100-240 VAC
Frequency	50-60 Hz
Current at 230V AC	0.9 A
Current peak	70 A
Efficiency	88%
Current leakage at 230V AC	<1mA
Input-output insulation voltage	3,000 VDC
Insulation voltage input-ground	2,000 VDC
Output voltage	12 VDC
Coverage IP	20
Coolant tank volume	2kg
Working temperature	+5 to +40°C
Storage temperature without extinguishing liquid	-40 to +80°C
Relative humidity (non-condensing)	20-90%
Dimensions: (width - height - depth)	483x45x495 mm
Weight without the extinguishing agent	11kg

## Construction

The body is of sheet metal steel. The tank and transport routes of the extinguishing agent are of stainless steel or non-corroding materials. All the materials are tested, they are resistant to the stated working conditions and the used extinguishing agent is stable throughout the service life of the device.

All the metal parts of the box, including the tank, are sprayed with black polyester powder paint (RAL 9005). The minimum layer of the coat is 60 µm. Adhesion corresponds to level 0-1 according to ČSN ISO 2409. The surface must not have defects such as abrasions, flashes, dirt, etc.

The mechanical design, including the layout of the equipment parts, is shown in Fig. 1.

### The fire fighting equipment consists of:

- **Tank with extinguishing agent (1)** consisting of non-pressure stainless storage vessel (1), filled with the extinguishing agent (FK-5-1-12, dodekafluor-2-methylpentan-3-on)). The volume of the tank is 2kg of the extinguishing agent.
- **Level gauge (2)** built-in to the left front of the tank. It is for continuously inspecting the amount of extinguishing agent. When the level falls below the adjusted limit, the "System error "signal is activated. At the same time, this situation can be signalled through the network.
- **Overpressure valve (3)** built-in to the left rear of the tank. It protects the equipment if the tank fails and is overheated above the permitted temperature limit when the extinguishing agent in the tank may turn to gas.
- **Suction valve (4)** built-in to the rear of the tank with no access from the outside. It removes under-pressure in the tank when the extinguishing agent is pumped from the tank (extinguishing).
- **Filling hole (5)** also built-in to the rear of the box but with access to the outside. It is closed by the 3/8 "cap . The filling hole is used to for add the extinguishing agent.
- **Pump (6)** when extinguishing it pumps the extinguishing agent from the tank. Then , the extinguishing agent is directed through hermetically sealed piping system, **an electromagnetic valve (7) and the nozzle (8)** and is sprayed under pressure into the protected space. The equipment can be used where installed and if re-filled, checked and used again.



CONTEG, spol. s r.o.

Na Vítězné pláni 1719/4, 140 00 Prague 4, Czech Republic

Tel.: +420 261 219 182, Email: [conteg@conteg.com](mailto:conteg@conteg.com), [www.conteg.com](http://www.conteg.com)

Company ID: 25701843, VAT ID: CZ25701843

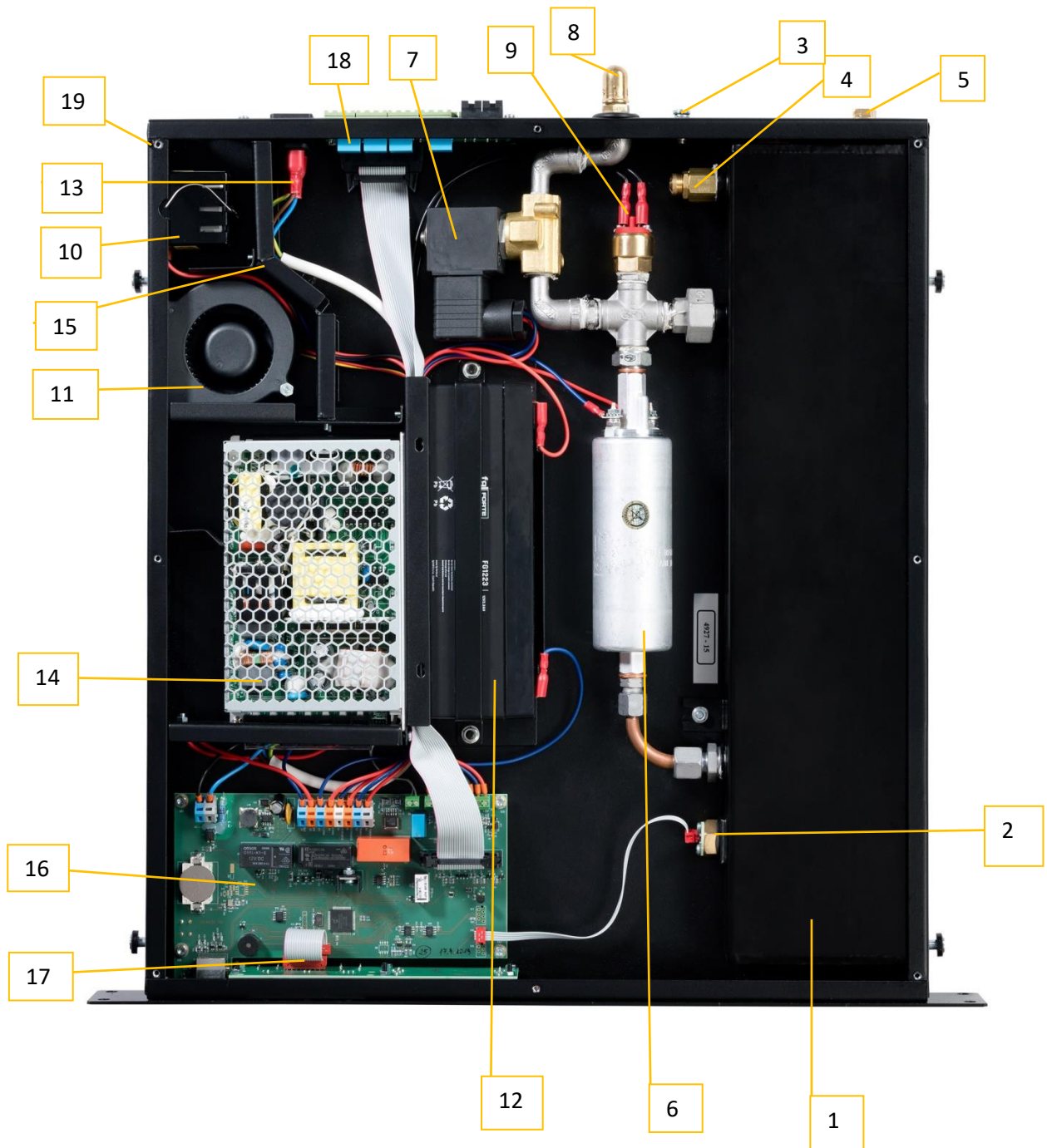

- **Pressure switch (9)** for inspecting the pressure on the pump output.
- **Smoke sensor (10)** built-in to the left rear of the tank. Air, with combustion products are sucked by the **radial ventilator (11)** from the monitored space through the hole in the rear wall of the box. Using a system of **curtains and partition walls (15)** is directed to the smoke sensor. Then it is flows back to the space through **DC source (14)**.
- **12V DC backup battery (12)** the system backup if the supply network breaks down or the DC source fails. The battery provides the energy requirements of the system during extinguishing.
- **AC inlet (13)** for connecting the **DC source (14)** to 230V AC distribution network.
- **Control board (16)** the heart of the system. It concentrates and evaluates the data from all inputs sensors. The whole system is controlled according to the results.
- **Manual control and local signalling board (17)** for manual control, inspection and ascertaining the system status. Unique indication of the equipment status by LED elements on the front panel reports any existing combination of system states of the equipment.
- **External inputs relay board (18)** collects external signals and controls the auxiliary devices of the system by internal relays.

## Control –activation

Before activating and commissioning fill the tank with extinguishing agent or check the extinguishing agent top it up, if necessary.

The equipment can be controlled by elements on the front panel or remotely by inputs on the rear panel.

The location of the control elements and signal lamps on the front panel is shown in Fig. No.:2.

All control elements and signal lamps are marked with a functional description - functional label.

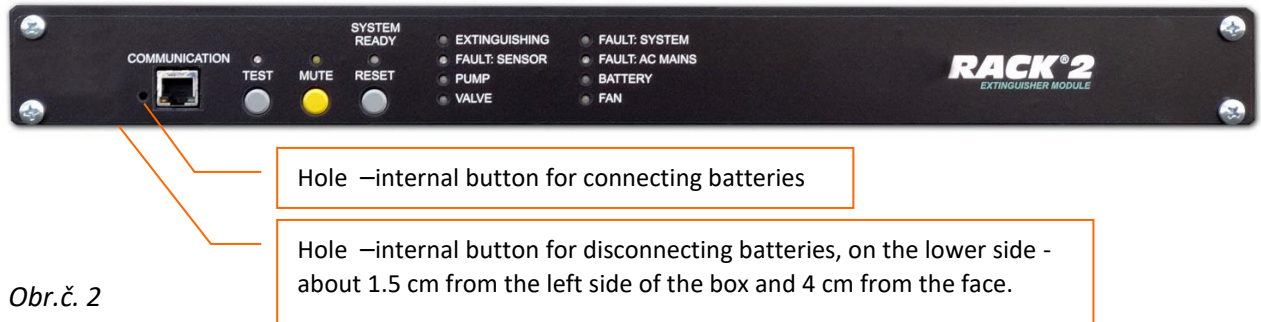

Obr.č. 2

Table No. 2 :

Operation		Activity:	Signalling		
			LED diode	colour	state
<b>INSTALLATION - ACTIVATION</b>	Inlet (13)	Connection of AC supply to the inlet. The system is under pressure, the GU1 source supplies 12V DC voltage	SYSTEM READY	G	B
		The battery is not connected inside the box, is missing or has insufficient capacity	BATTERY	---	---
		The battery is connected, electrically disconnected	BATTERY	R	S50%
	GB1 battery connection	Using an up to 3mm diameter rod (ball point pen) lightly press the micro switch to the left of the communication connector. The internal relay is activated (a click is heard) and connects the battery to the system.	BATTERY	G	S
	De-aerating the pump	after adding fuel or after handling the equipment outside the 19 "frame. Press TEST + MUTE, the pump is activated, the system is pressurized after disconnecting the pressure switch (max. 10 sec.)	PUMP	G	S
		The 10 sec limit is exceeded and it is not pressurized. Repeat the procedure if it is not pressurized. If there is no pressure, then the pump or transport route of the extinguishing agent has failed	PUMP	R	S
<b>TEST</b>	Equipment test (without extinguishing)	Press the "TEST "button to block the pump and electromagnetic valve to prevent the extinguishing agent escaping. The other processes run as with a real fire and extinguishing	TEST	B	S
		Spraying testing gas into the suction hole or near it will activate the smoke sensor	EXTINGUISHING	R	S50%

<b>TEST</b>		<p>After the 3 seconds command extinguishing starts accompanied by an acoustic signal. The sound signal can be deactivated by the "MUTE" button. After extinguishing, the smoke sensor is activated and it must be deactivated by the "RESET" signal</p> <p>Pressing the "RESET" switch activates the operation of system restoration</p> <p>After the termination of the system restoration process by reset, the system is ready for normal operation. The state is signalled.</p> <p>If the horn was deactivated by "MUTE", press "MUTE" again to activate it. The "MUTE" signal lamp goes off.</p>	EXTINGUISHING	R	S
			SYSTEM READY EXTINGUISHING	R R	B S
			EXTINGUISHING SYSTEM READY BATTERY	--- G G	--- B S
			MUTE	Y ---	S ---
<b>DISCONNECTING THE EQUIPMENT</b>	Disconnecting batteries	<p>If the equipment was disconnected from the network supply for a long time, the battery will be gradually discharged. In this case electrically disconnect the batteries from the system. This can be done in two ways:</p> <ul style="list-style-type: none"> <li>- by pressing "TEST" + "RESET" at the same time</li> <li>- by switching the micro switch in the left lower part of the box which is accessible from the bottom after partially ejecting the box (about 5 cm) from the 19 "frame.</li> </ul>	BATTERY	R	S50%

## Extinguishing

After filling the tank with the extinguishing agent, mounting the equipment in the 19 "frame, testing it and connecting the batteries, the equipment is ready for normal operation.

Table No. 3 :

Operation		Activity:	Signalling		
			LED diode	colour	state
<b>EXTINGUISHING</b>	Activation	<p>The signal to activate "Extinguishing" can be done in several ways i.e.:</p> <ul style="list-style-type: none"> <li>- by the LES-RACK-M1 internal sensor</li> <li>- by the external manual button</li> <li>- by a signal from the external sensors</li> <li>- by a command through the network</li> </ul> <p>After activation for 3 seconds</p>	EXTINGUISHING	R	S50%
	Extinguishing	<p>After 3 seconds the extinguishing command is activated. The electromagnetic valve is opened and the pump is activated.</p> <p>Selected output relays are activated.</p> <p>The extinguishing is accompanied by an acoustic signal. The sound signal can be deactivated by the "MUTE" button.</p> <p>After pressing the "MUTE" button, the internal and external horns are deactivated</p>	EXTINGUISHING VALVE PUMP MUTE	R G G Y	S S S S



	After the extinguishing agent is discharged, the pump and the valve are disconnected. The extinguishing ends. For information about the extinguishing, the extinguishing signal lamp continues to shine and because the system has no extinguishing agent, a system error is activated	VALVE · PUMP · EXTINGUISHING · FAULT SYSTEM	--- --- R R	--- --- S S
--	---	---	----------------------	----------------------

EXTINGUISHING	Termination	After extinguishing, the smoke sensor is activated and it must be deactivated by the "RESET" signal After the "RESET" command, the extinguishing signal goes off, the system error continues to shine.	EXTINGUISHING · FAULT SYSTEM	--- R	--- S
	Adding the extinguishing agent, de-aerating the pump	Eject the equipment from the 19" frame, disconnect the connectors of the external equipment and remove it. After removing the filling hole cap in the rear face add the extinguishing agent. After the adding the extinguishing agent, seal the filling hole with the cap, connect the external equipment on the rear face and insert the equipment back into the frame. Secure The system error signal goes off.  Press TEST + MUTE, the pump is activated, the system is pressurized after disconnecting the pressure switch (max. 10 sec.)  The 10 sec limit is exceeded and the system is not pressurized. Repeat the procedure if it is not pressurized. If there is no pressure, then the pump or transport route of the extinguishing agent has failed  TEST the equipment. The procedure is identical to the procedure described in "Restoration".	FAULT SYSTEM  PUMP  PUMP	--- G R	--- S S

### Inputs and Outputs

The rear of the box has a relay board with 4 relays on the inside to control the external equipment. The board has connectors on the outside side to connect signals from the input sensors and connectors for switching the external equipment. All connectors are marked with a function description - functional label.

The location

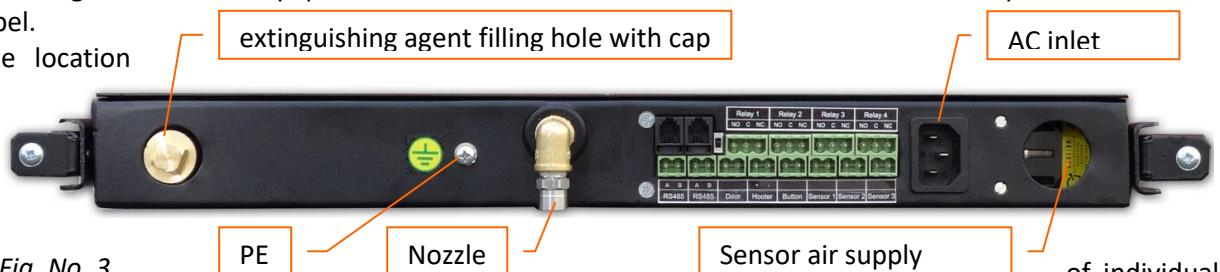

Fig. No. 3

3 and 4

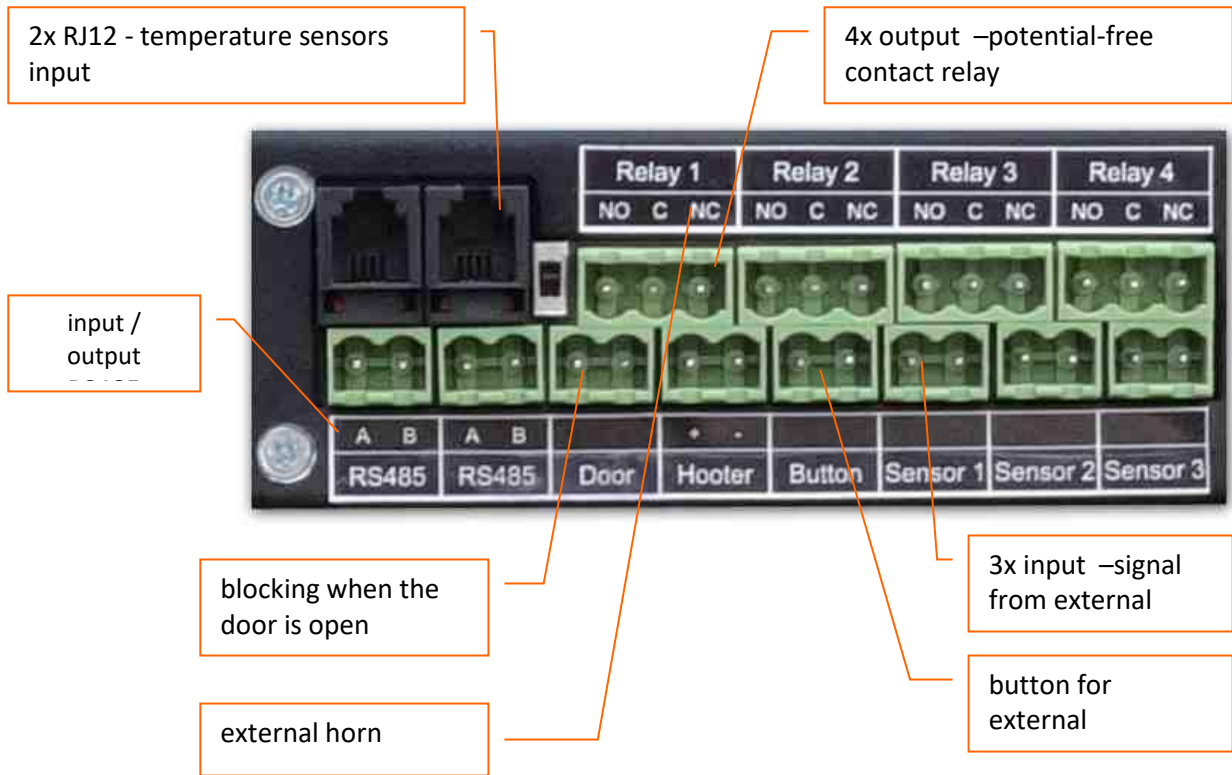

Fig. No. 4

- **Relay outputs.** LES-RACK-M1 has 4 relay outputs with one switching contact. Individual relays switching during extinguishing can be user adjusted. The software can be set so that these relays also react in the “TEST” mode. The maximum switching voltage and currents are given in Table No. 4.

Table No. 4 :

Network:	U <sub>max</sub>	I <sub>max</sub> / U <sub>n</sub>
AC	60V	0.5
DC	24V	0.5

- **Door contact** blocks extinguishing when the door is opened. Opening the door activates the door switch and extinguishing is blocked. When the door is opened, the extinguishing agent would escape outside the monitored space and its concentration for effectively extinguishing a fire would be insufficient. The integrity of the circuit of the door contact is continuously monitored.

The connection diagram for the door contact is in Fig. No.:5

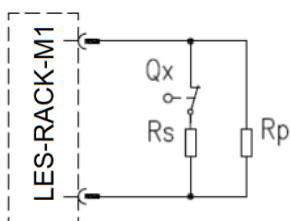

The extinguishing blocked state is displayed on the front panel by a yellow shining signal “EXTINGUISHING” light

The resistance values in the diagram are as follows:

R<sub>p</sub>: 1K8 Ohm, 0.1 W

R<sub>s</sub>: 470 Ohm, 0.1 W

Fig. No. 5

- **The external horn** provides an acoustic signal in other premises away from the monitored space. The external horn is activated together with the extinguishing command. It can be disconnected by the "MUTE" button on the LES-RACK-M1 front panel.  
The horn supply is 12V DC, maximum current 150 mA
- **The manual activation button** activates extinguishing from other places than the monitored space. The integrity of manual activation button is continuously monitored.  
The connection diagram for the door contact is in Fig. No.:6

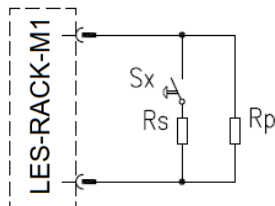

Fig. No. 6

The resistance values in the diagram are as follows:

Rp: 1K8 Ohm, 0.1 W

Rs: 470 Ohm, 0.1 W

- **External sensors.** The extinguishing process can be remotely activated by signals for the other detectors or other extinguishing equipment. The inputs marked with the text "Sensor 1" to "Sensor 3" are for this.

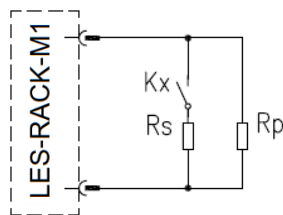

Fig. No.

The sensitivity of the external sensors circuits is also continuously monitored.

The connection diagram for the external sensors is in Fig. No.:7

The resistance values in the diagram are as follows:

Rp: 1K8 Ohm, 0.1 W

Rs: 470 Ohm, 0.1 W

- **External temperature sensor** - installed in the space where the temperature must be monitored. The temperature sensor checks the temperature in the monitored space. If the default temperature limits are exceeded, the user selected relay is activated.

## Signalling

Local signalling is by multi-coloured LED diodes under the labels of the function description of the respective device or the system state. Individual statuses are described in Table No. 5.

The meaning of the letters in the "colour" column are as follows:

<b>R</b>	-	<b>red</b>
<b>G</b>	-	<b>green</b>
<b>Y</b>	-	<b>yellow</b>
<b>B</b>	-	<b>blue</b>
<b>O</b>	-	<b>orange</b>

R/G - alternating colours red / green

The meaning of the letters and numbers in the “status” column is as follows:

- - does not shine
- S50% - shines with decreased intensity
- S - shines permanently
- B - flashes

Table No. 5 –Local signalling

LED diode:	Signalling:		Meaning of the signalling:
	colour:	status:	
TEST	---	---	The system is prepared, normal operating status.
	<b>B</b>	<b>S</b>	The system is in the running test regime.
MUTE	---	---	Sound equipment is on, prepared.
	<b>Y</b>	<b>S</b>	The sound equipment is deactivated , disconnected when running the message.
SYSTEM READY	---	---	The system is disconnected from the supply sources, non-functional
	<b>G</b>	<b>B</b>	System OK.
	<b>R</b>	<b>B</b>	Only briefly, when resetting the system
	<b>R/G</b>	<b>B</b>	State “prepared for reset of the whole system. Special regime after a long press of the “RESET” button. Described below in the software setting of the network
EXTINGUISHING	<b>R</b>	<b>S50%</b>	3 seconds delay before extinguishing activated.
	<b>R</b>	<b>S</b>	Extinguishing in progress or terminated.
	<b>Y</b>	<b>S</b>	Extinguishing blocked, door open
FAULT SENSOR	<b>R</b>	<b>S</b>	Fault sensor
PUMP	<b>G</b>	<b>S</b>	The pump pumps
	<b>Y</b>	<b>S</b>	Lights in the de-aerating regime, pump flooding (“TEST” + “MUTE”)
	<b>R</b>	<b>S</b>	Pump failure
VALVE	<b>G</b>	<b>S</b>	The valve is open
	<b>R</b>	<b>S</b>	Valve failure
SYSTEM FAULT	<b>R</b>	<b>S</b>	Major fault when the system need not but can extinguish (small amount of extinguishing agent. . .).
	<b>Y</b>	<b>S</b>	Minor fault that does not prevent extinguishing.
AC MAINS FAULT	---	---	AC supply OK
	<b>R</b>	<b>S</b>	AC network fault, AC breakdown, interrupted supply
BATTERY	---	---	Does not shine, battery missing, battery inlets disconnected.
	<b>R</b>	<b>S50%</b>	Shines with low intensity The battery is in the system, battery inlets not connected, electrically not connected to the system.
	<b>R</b>	<b>S</b>	Battery fault
	<b>Y</b>	<b>S</b>	Battery test in progress
	<b>G</b>	<b>S</b>	Battery connected, battery parameters . OK
FAN	<b>R</b>	<b>S</b>	Fan fault , fan does not rotate
	<b>ON</b>	<b>S</b>	Insufficient fan revolutions, decreased output.
	<b>G</b>	<b>S</b>	The fan is OK.

## General safety provisions

Activation of the LES-RACK-M1 fire extinguisher may create risks for the user because of the natural form of the extinguishing agent or from decomposition products from the contact of the extinguishing agent with the fire or hot surfaces. The equipment user must prevent any affect on the operators by the extinguishing agent, as well as decomposition products, mainly by regular training. The start of the fire extinguisher may be accompanied by a loud noise that could cause fright, but not so loud as to cause traumatic injury. The extinguishing agent is discharged from the nozzle of the equipment in a high speed flow with sufficient force to move items in its route or near it. The discharged extinguishing agent may cause in the protected space sufficient flowing to make light unsecured objects move.

## HTML

For displaying and setting the network parameters

Default values:

IP address: **192.168.1.103**

Mask: **255.255.255.0**

Gate: **192.168.1.1**

Name: **admin**

Password? **admin**

Login (name and password) needed to save the set values. If the user does not login or types incorrect login data, the button for saving the values is not accessible (login error is not displayed). To repeat the login, close the browser and run it again (it is its property and it is not possible to do otherwise)

**NOTE:** *Transferred login data is not encrypted.*

**ATTENTION:** *The display may not be correct on older versions of browsers.*

## State

Basic screen that displays states similar to the front panel.

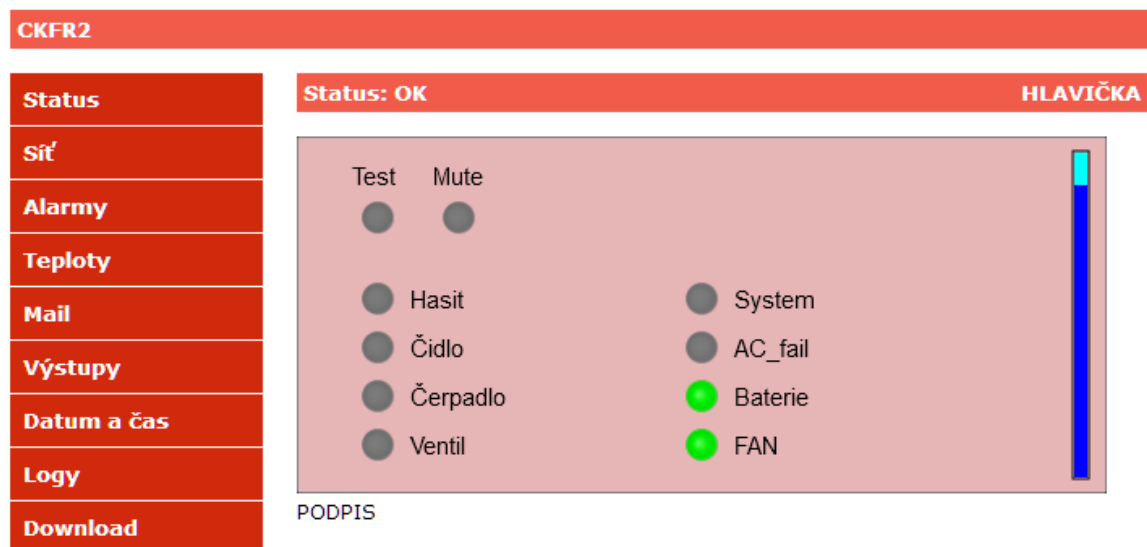

(FW: 1.0.02)

Menu:

State –state window

Network –setting the network

Alarms –setting alarms

Temperatures –setting temperature sensors

Mail –setting e-mail

Outputs –control of output relays

Date and time –setting the date and the time

Logs –history of events

Download –MIB tree for SNMP and logs as CSV

State window:

Shows the state of the exchange. On the right there is an extinguishing level indicator.

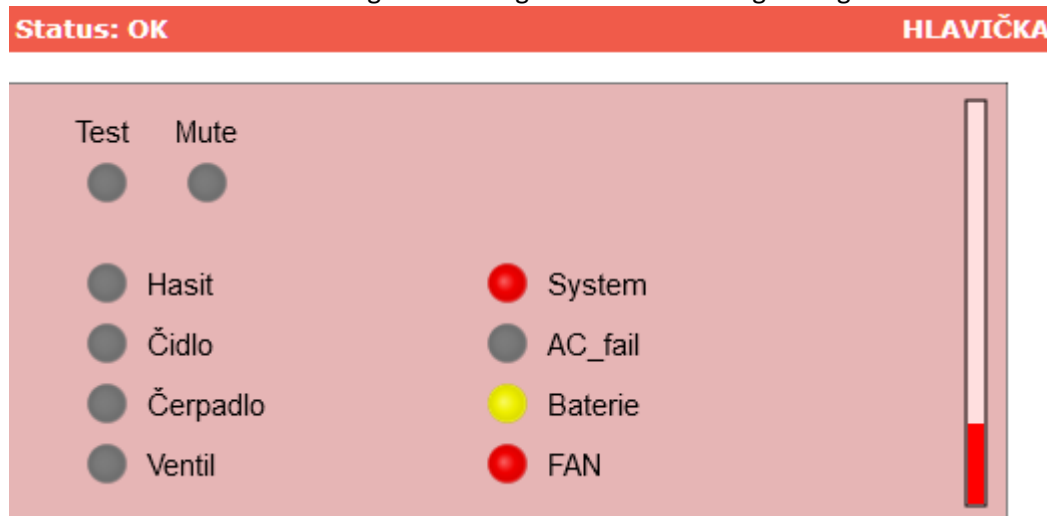

Here, the state is displayed, when:

- MAJOR system error (MINOR is in yellow)
- The battery is disconnected from the system but it is present.
- The fan is not rotating.
- The level is low.

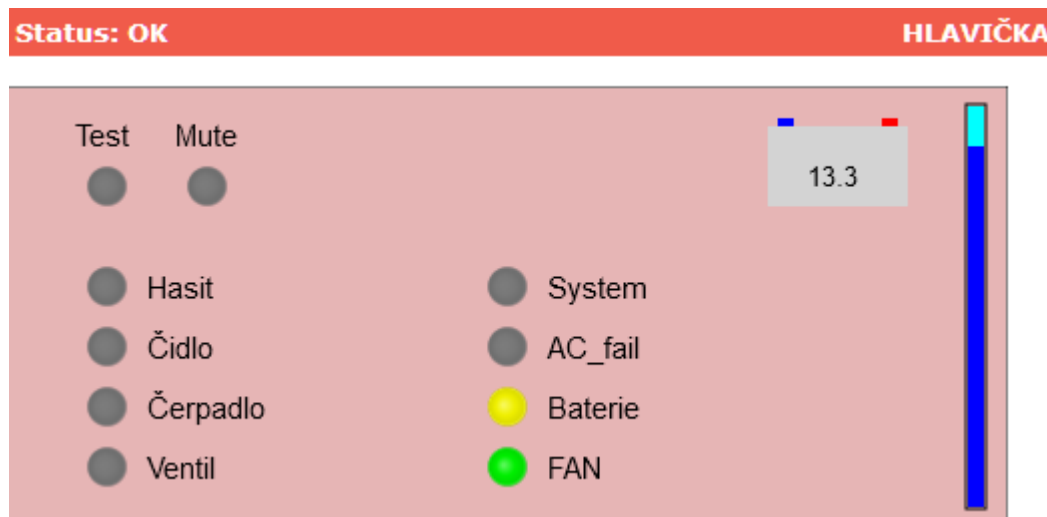

Here, the state is displayed, when:

- The fan is rotating.
- The battery is in the test.
- The level is OK.

If the system fault is active (MINOR, MAJOR), display details of the fault by pressing the LED.

**Alarmy:**

Hladina nízká MAJOR

Network



**UPOZORNĚNÍ:** Špatné nastavení může způsobit nefunkčnost komunikace. Pomocí tlačítka Reset na zařízení se nastaví defaultní hodnoty

<b>IP Adresa:</b>	<input type="text" value="192.168.1.103"/>
<b>Brána:</b>	<input type="text" value="192.168.1.1"/>
<b>Maska sítě:</b>	<input type="text" value="255.255.255.0"/>
<b>Primární DNS:</b>	<input type="text" value="192.168.1.1"/>
<b>Sekundární DNS:</b>	<input type="text" value="0.0.0.0"/>
<b>SNMP trap1 IP:</b>	<input type="text" value="0.0.0.0"/>
<b>Port:</b>	<input type="text" value="162"/>
<b>Community:</b>	<input type="text" value="public"/>
<b>SNMP trap2 IP:</b>	<input type="text" value="0.0.0.0"/>
<b>Port:</b>	<input type="text" value="162"/>
<b>Community:</b>	<input type="text" value="public"/>
<b>TCP port:</b>	<input type="text" value="9761"/>
<b>UDP port:</b>	<input type="text" value="30306"/>
<b>Read community:</b>	<input type="text" value="read"/>
	<input type="text" value="public"/>
	<input type="text"/>
<b>Write community:</b>	<input type="text" value="write"/>
	<input type="text" value="private"/>
	<input type="text"/>
<b>Refresh HTML:</b>	<input type="text" value="1000"/>
<b>Typ:</b>	<input type="text" value="CKFR2"/>
<b>Hlavicka:</b>	<input type="text" value="HLAVIČKA"/>
<b>Podpis:</b>	<input type="text" value="PODPIS"/>
<b>Skupina hasit:</b>	<input type="text" value="0"/>
<b>Uživatel:</b>	<input type="text" value="admin"/>
<b>Heslo:</b>	<input type="text" value="*****"/>
	<input type="button" value="Ulož &amp; Reboot"/>

IP address: exchange address

Gate: must be typed even if it is not used

Primary and secondary DNS: if mail is used

SNMP trap1,2:

    IP : SNMP address of the server

Port: default is 162, it can be changed if the server on this port catches traps from other equipment

Community : traps community

TCP port: for TCP communication

UDP port : port UDP communication

Read, Write community : SNMP community

Refresh HTML: time in ms, during which the content of the state window is refreshed

Type: the text appears in the header of the page

Header: text in the title of the window

Description: text under the state panel (with HTML tags reference to the web pages can be displayed)

Group extinguish: group for common extinguishing. If the exchanges have the same group (with the exception of 0), if extinguishing is activated on any of them, extinguishing on the others is activated.

User, Password: change access data.

Note: if you forget the IP address or the password, set them to default values as follows:

- press RESET on the exchange and hold it as long as the green and red alternatively flash (about 5 seconds) then release it. Now you have a choice:
  - press the TEST button and the exchange is reset with the default values of the IP address and the password
  - press the MUTE button and the exchange is only reset
  - press the RESET button and this regime is terminated (nothing is done)

## Alarms

Nastavení alarmů		HLAVIČKA
<b>Vyber alarm:</b>	7 Senzor1	SEP: 000
<b>Text:</b>	Senzor1	
<b>Trap:</b>	<input type="checkbox"/>	
<b>Mail:</b>	<input type="checkbox"/>	
<b>Error Major:</b>	<input type="checkbox"/>	
<b>Error Minor:</b>	<input type="checkbox"/>	
<b>Stav Major:</b>	<input type="checkbox"/>	
<b>Stav Minor:</b>	<input type="checkbox"/>	
<b>Hasit:</b>	<input type="checkbox"/>	
<b>Blokace:</b>	<input type="checkbox"/>	
<b>Relé1:</b>	<input type="checkbox"/>	
<b>Relé2:</b>	<input type="checkbox"/>	
<b>Relé3:</b>	<input type="checkbox"/>	
<b>Relé4:</b>	<input type="checkbox"/>	
<input type="button" value="Ulož"/>		

Select the alarm with which you want to work

SEP : displays the actual state of the alarm (state, error, auxiliary state)

Text : description of the alarm –for display in the log and SNMP protocol

Trap : change of the state or failure sends the trap

Mail : change of the state or error sends e-mail

Error Major : error is assigned to Major

Error Minor : error is assigned to Minor

State Major: the state is assigned to Mirror

State Minor: the state is assigned to Minor

Extinguish: State 1 starts extinguishing

Blocking: State 1 blocks the extinguishing

Relay 1-4 : The state controls relay

**NOTE: For other alarms, all possibilities need not be accessible.**

## Temperatures

### Nastavení teplot

HLAVIČKA

Načti číslo

<b>Vyber teploměr:</b>	Teplota2	22,8°C
<b>Linka:</b>	Ext. 1	
<b>Seriové číslo:</b>		
<b>Relace:</b>		
<b>Mez:</b>	0,0	
<b>Hystereze:</b>	0,0	
	<b>Ulož</b>	

Up to 4 temperature sensors can be connected to the exchange. They are digital sensors, so they can be connected to one bus-bar. The maximum length of all conductors should not exceed 10 metres. The exchange has two inputs for these sensors.

Select thermometer: select the thermometer with which you want to work. The actual temperature is shown on the right.

Line: select the input to which the sensor is connected

Serial number: if there is only one sensor on the line, it remains empty. If there are more sensors on the line, this number states the specific sensor.

Procedure for typing the serial number : connect only one sensor on the line and press the "Read sensor" button and press the "Save" button. Then select the temperature, type the line, disconnect the first sensor and connect the second sensor, read serial number and save. Repeat the procedure for the next sensor. Finally, connect all the sensors.

Summary:

- if there is only one number on the line, it is not necessary to type a serial number.
- two sensors can be connected to the exchange –advantage –when replacing the sensor (defective, longer conductor needed) nothing needs to be set.
- if there are more sensors on the line, they must have serial numbers –when replacing the serial numbers must be read

Relation:



Limit:

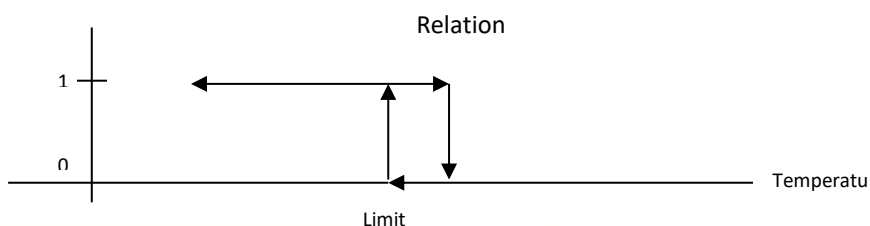

The result of setting is to change the state of the alarms 25 –28.

## Mail

**Nastavení mailu** **HLAVIČKA**

**Server:**

**User:**

**Password:**

**To:**

**From:**

**Subject:**

Server : SMTP server

User, Password : SMTP server requires login

To : addressee of the mail





From : sender of the mail - must be typed

Subject : Subject of the message

## Outputs

“Relay\_ “window used to change the name of the output. The new name is saved by the “>” button  
“Switch ”window used to manually switch the respective relay.

**Výstupy** **HLAVIČKA**

<input type="text" value="Relé1"/>	>		<input type="button" value="Přepni"/>
<input type="text" value="Relé2"/>	>		<input type="button" value="Přepni"/>
<input type="text" value="Relé3"/>	>		<input type="button" value="Přepni"/>
<input type="text" value="Relé4"/>	>		<input type="button" value="Přepni"/>

## Date and time

Nastavení času		HLAVIČKA
27.03.19 08:28:36		
<b>Datum:</b>	<input type="text" value="dd.mm.rr"/>	
<b>Čas:</b>	<input type="text" value="hh:mm:ss"/>	
<input type="button" value="Ulož"/>		

## Logs

Lists events from the newest to the oldest.

Logy		HLAVIČKA
Řádků na stránku :	<input type="text" value="20"/>	Strana : <input type="button" value="&lt;&lt;"/> <input type="button" value="&lt;"/> 1 <input type="button" value="&gt;"/> <input type="button" value="&gt;&gt;"/>
<hr/>		
2019.03.27 08:18:02 <- Major 1 0		
2019.03.27 08:17:45 <- Ventilátor 0 1		
2019.03.27 08:14:47 <- Ventilátor 1 0		
2019.03.27 08:09:45 <- Ventilátor 0 1		
2019.03.27 08:09:08 <- Ventilátor 1 0		
2019.03.27 08:08:49 <- Minor 0 0		
2019.03.27 08:08:47 <- Minor 1 0		
2019.03.27 08:08:46 <- Major 0 0		
2019.03.27 08:08:36 <- Baterie 1 0		
2019.03.27 08:06:26 <- Major 1 0		
2019.03.27 08:01:52 <- Major 0 0		
2019.03.27 08:01:50 <- Major 1 0		
2019.03.27 08:01:40 <- Major 0 0		
2019.03.27 08:00:35 <- Major 1 0		
2019.03.27 08:00:23 <- Major 0 0		
2019.03.27 07:41:54 <- Reset 1 0		
2019.03.27 07:41:41 <- Test 0 0		
2019.03.27 07:41:40 <- Test 1 0		
2019.03.27 07:36:54 <- Ventilátor 0 1		
2019.03.27 07:36:31 <- Ventilátor 1 0		
Další strana		

## Download

Download		HLAVIČKA
<a href="#">MIB</a>		
<a href="#">LOG</a>		
MIB –opens the MIB file window		
LOG –opens events window		

# INSTALLATION

## General provisions

Equipment **LES-RACK-M1** is designated for the installation in closed spaces without the occurrence of aggressive substances. The equipment must not be at risk of mechanical damage, the effects of direct sunlight and working conditions outside the permitted limits. Before locating and installing, please read the local fire and safety regulations.

## Safety provisions

For protection against electric current, EN 50110-1 Operating and work on electric equipment applies. The equipment must only be installed by certified subjects according to EC No. 842/2006 and instructed at least according to Section 4 of Regulation No. 50/1978 Coll., or No. 51/1978 Coll. These subject must not interfere with the circuits, parts of linked networks under the cover because there is a risk of an electric shock. The equipment must not be put into operation without the initial revision.

## Assembling the equipment

The equipment is constructed for universal installation in all types of 19" boxes. It must only be installed by the face panel to the door of the box into special leading skids which are included.

The skids are inserted between the front and rear 19 "bar or between the front 19 "bar and the frame of the box. From the front the skid has 3 holes with M5 threads with the same pitch as the 1U drilling in the 19 "bar.

Fix the bar to the rear wall of the front 19 "bar using the conical headed M5 bolt. The remaining two bolts are used to fix the LES-RACK-M1 and ejecting it into the skids and pushing it to the face of 19 "bar. The rear of the skid has a movable foot with a centric M5 hole for fixing to the rear bar or the frame of the box.

During assembly proceed so that the leading skids are fixed to the box first. Then connect all the external equipment and consequently insert the LES-RACK-M1 by the side pins on the box into the leading skids, push to the face of the 19 "bar and using 4 M5 bolts screw with the skid.

Before assembly make sure there is sufficient space for the assembly in the box. During assembly the

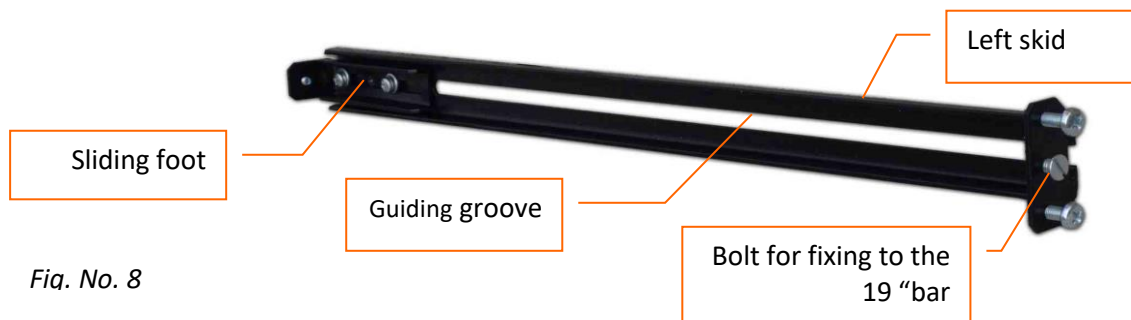

Fig. No. 8

horizontal working position must be kept.

## Filling, adding extinguishing liquid

The extinguishing liquid is filled or topped up through the LES-RACK-M1 filling hole on its rear. The hole is accessible after removing the LES-RACK-M1 from the box.

Filling procedure:

- Remove the LES-RACK-M1 from the box and turn it downwards so that the face for the filling hole is upwards.
- Remove (unscrew) the filling hole cover
- Insert a funnel into the filling hole. The maximum diameter of the lower part of the neck of the funnel is 14 mm.

- After inserting the funnel start filling or topping up the extinguishing liquid. Fill slowly as the inflow opening is small.
- After filling with the necessary amount of liquid remove the funnel.
- After filling, re-screw the filling hole cover and gently tighten
- Return the LES-RACK-M1 into the horizontal (working) position and place it back in the box
- De-aerate the pump with the “TEST”+ “MUTE ”buttons

## CHECKING AND COMMISSIONING

### Commissioning

The procedure for commissioning equipment is given in Table No. 2 “INSTALLATION - ACTIVATION”.

### Checking

The function of the equipment is checked exclusively in the TEST regime.

The procedure for commissioning is given in Table No.2 “TEST”.

### Disconnecting equipment

The equipment is disconnected by stopping the supply from the distribution network and, at the same time, disconnecting the battery.

The supply from the distribution network is stopped by disconnecting the circuit breaker (switch) or by disconnecting the supply cable from the AC inlet on the equipment.

The battery is disconnected by pressing and holding the “TEST ”button and pressing the “RESET ”button on the front panel of the equipment.

**NOTIFICATION:** *If equipment is disconnected for more than 4 months it must be connected to the network and operated (connect the battery). It must be connected for at least 12 hours to charge the backup source (battery). After charging, the equipment must be disconnected and then it is possible to put it aside again.*

## SERVICING

### General requirements

The LES-RACK-M1 equipment is designed and produced for fully automated operation. The front panel contains the signal LED elements providing information about the state and running processes of the equipment. The list of local signals is given in Table No. 5.

The cover of the equipment must only be opened by a person authorized by service organization. After opening the cover there is a risk of an electric shock. The equipment user must state and train a person responsible for operation of the equipment, persons authorized to operate the equipment and authorized maintenance personnel who must be familiarized in detail with this user manual. For instructing maintenance employees of other equipment, correct procedures must be put in place so that during their activities they do not activate fire extinguisher. It is recommended to state that unauthorized persons are prohibited or their entrance into premises of the equipment is controlled.

## MAINTENANCE

### General provisions

The user must carry out program inspections, ensure planned repairs and keep records about inspections and repairs. The user must prevent leaks and immediately repair ascertained leaks according



to EC Np. 842/2006 Article 3. The ability of the LES-RACK-M1 equipment to continuously perform effectively completely depends on adequate servicing and regular testing. The LES-RACK-M1 equipment must only be inspected by persons who meet the required qualification conditions. These persons must not interfere with the circuits, parts linked with the network under the cover under any circumstances because there the risk of an electric shock. Repairs must only be carried out by properly trained employees of the service organization or the manufacturer. Before the inspection, the person responsible for the operation of equipment must be informed about the inspection of the equipment LES-RACK-M1. Before the inspection and commissioning, related equipment, if any is connected, must be prevented from running, e.g. disconnecting energy, fire valve, air conditioning unit. The equipment must be inspected after each use or if the permitted working limits are exceeded.

### Inspections by the user

Consistent adherence to the inspection time schedule and maintenance is carried out to ascertain defects in the LES-RACK-M1 equipment in the initial stage. Allows correction before the equipment is automatically activated and error-free function in the case of fire. The inspections of equipment must always prove conformity with the general requirements and technical parameters in this manual.

#### Inspection after 1 week

Visual inspection of any risk changes and the tightness of the protected space that would decrease the efficiency of the system. Visual inspection to see that the operating equipment and components of the system are properly located and undamaged.

Inspection of signal lamps on the front panel

#### Inspection after 1 month

Checking that all staff who could work with equipment are properly trained and have appropriate qualifications. In particular that new employees were familiarized with the use and operation of the system.

#### Checking the protected space

At least each month consistently check that there are no passages in the borders of the protected space or that other changes have not occurred that could influence the escape of the extinguishing agent or its efficiency. If it is ascertained that in the protected space changes in the volume or the type of the risk have occurred, the extinguishing system must be modified so it provides the original level of protection. It is recommended the type of the risk in the protected space and the volume which is occupied. It is recommended to regularly check that the extinguishing agent is at the required concentration and will be kept.

### Inspections by the service organization

Repairs must only be carried out by properly trained employees of the service organization with electric systems qualifications according to the respective regulations.

All electric detection and alarm systems are tested according to the recommendations of the respective national standards.

All control valves are checked that they work correctly in manual operation and, consequently, that they work correctly for automatic operation. Checking the surface of the equipment for signs of damage or unauthorized interference.

Visual inspection

- checking the equipment location
- checking the serial number
- checking equipment fixing
- checking equipment accessibility
- cleaning dirt from the system

Notification: The producer of this document, reserves the right to change the contents without prior notification.